

① 車体

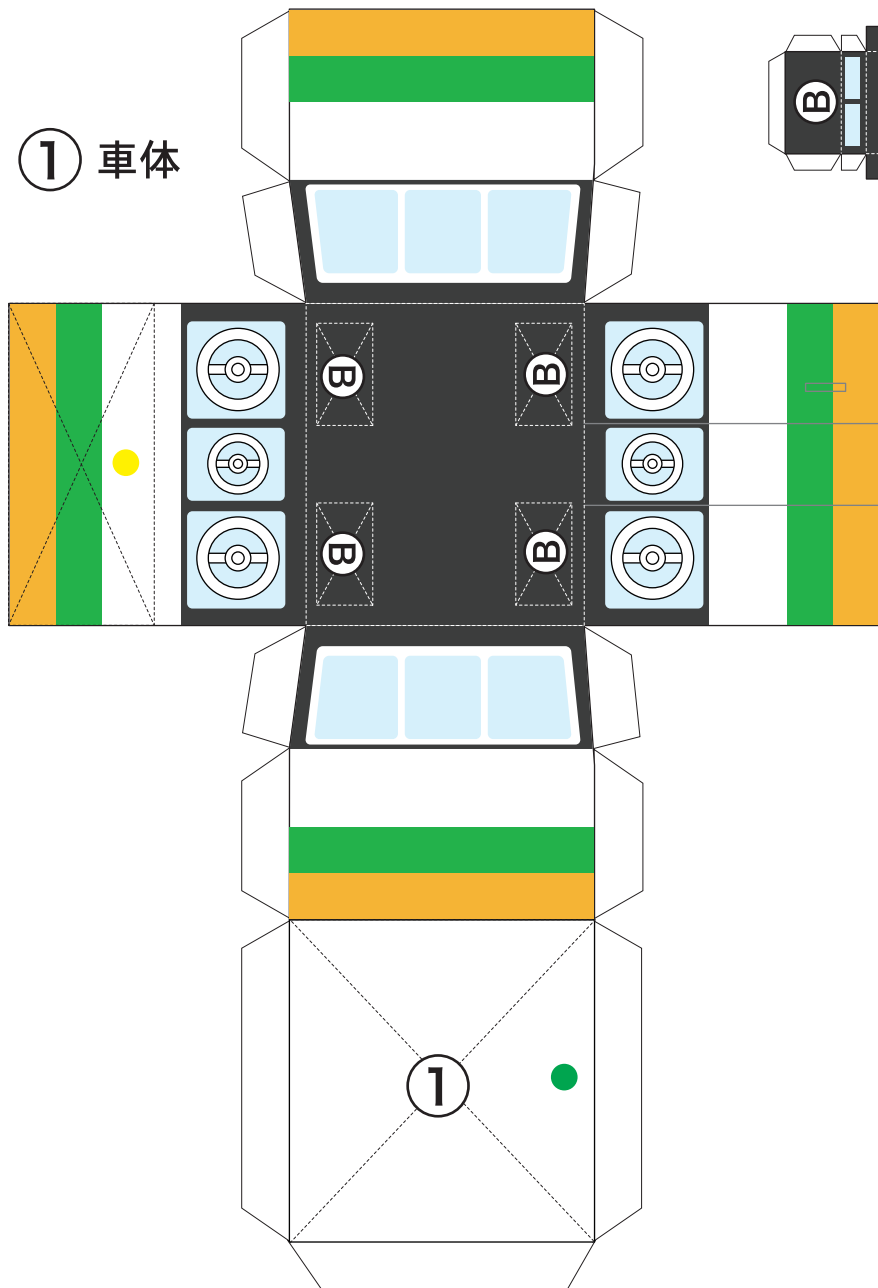

② ライト

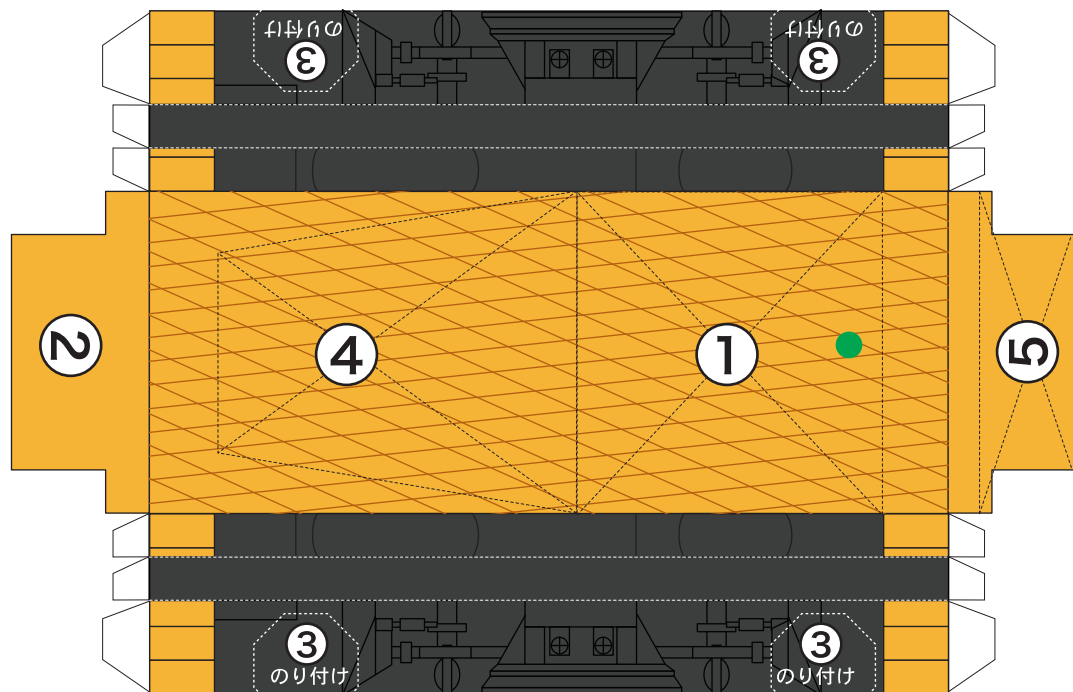
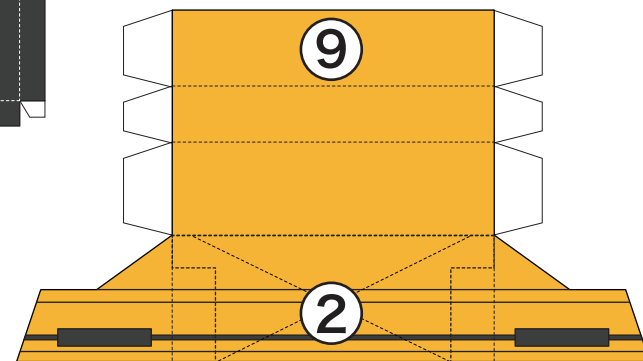
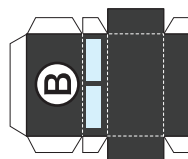
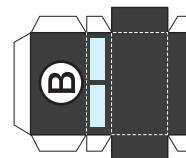
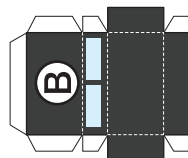
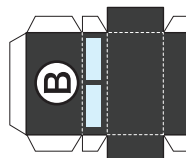

HTR600R 軌道モーターカー

----- 折り線

⊠ 部品貼り付け

● 切り抜き

↶ 裏返してのり付け

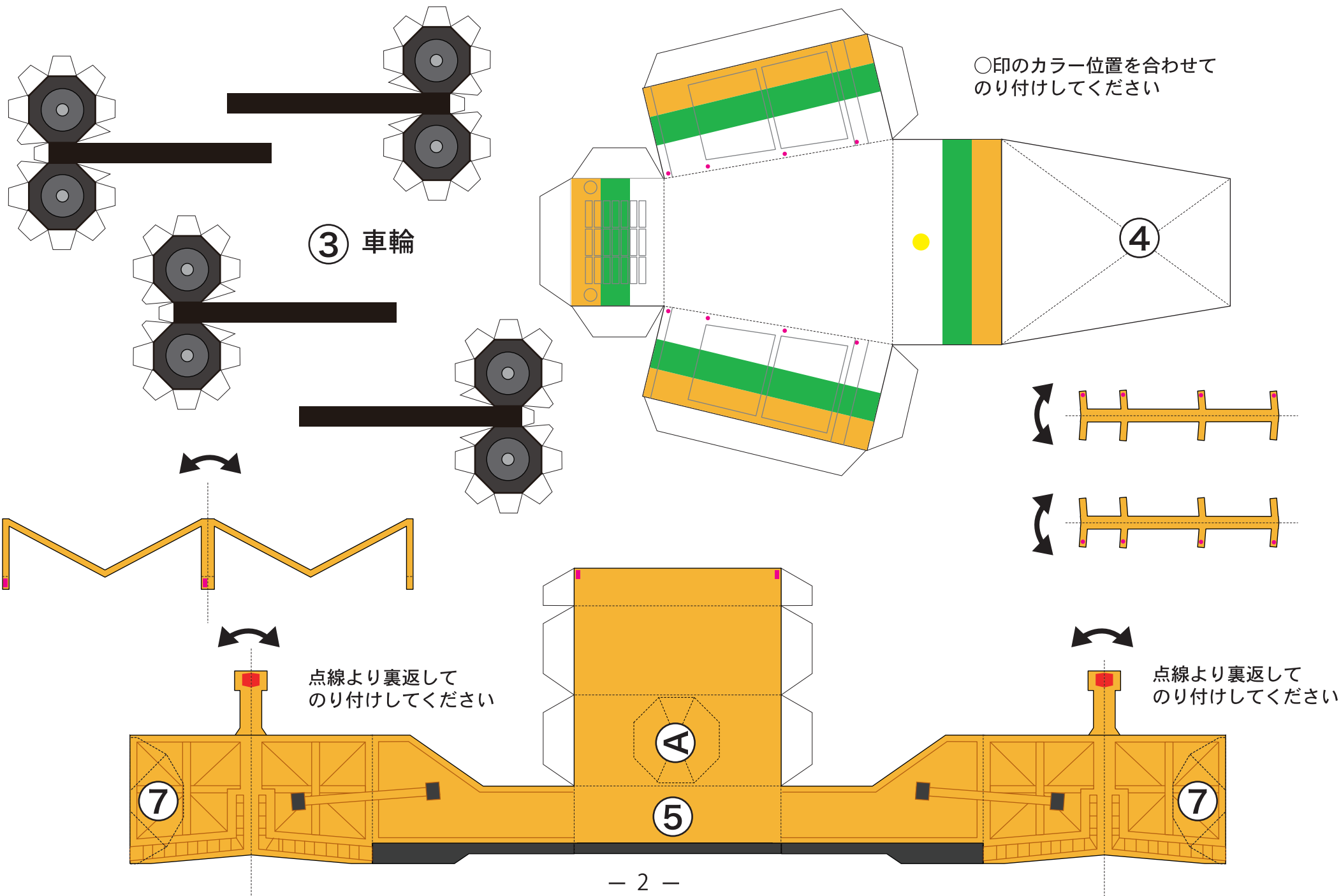

点線より裏返してのり付けしてください
●はのりしろになります。

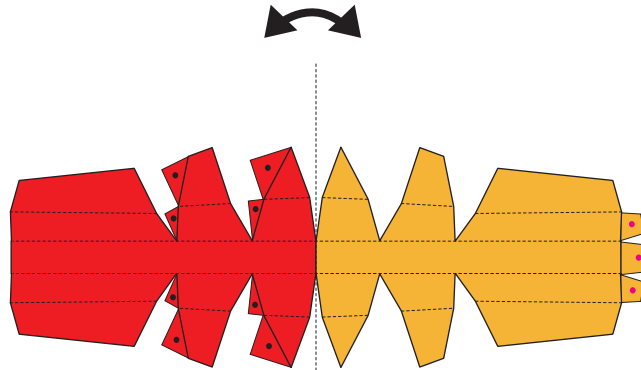

赤いのりしろは
内側の赤い面にのり付けしてください

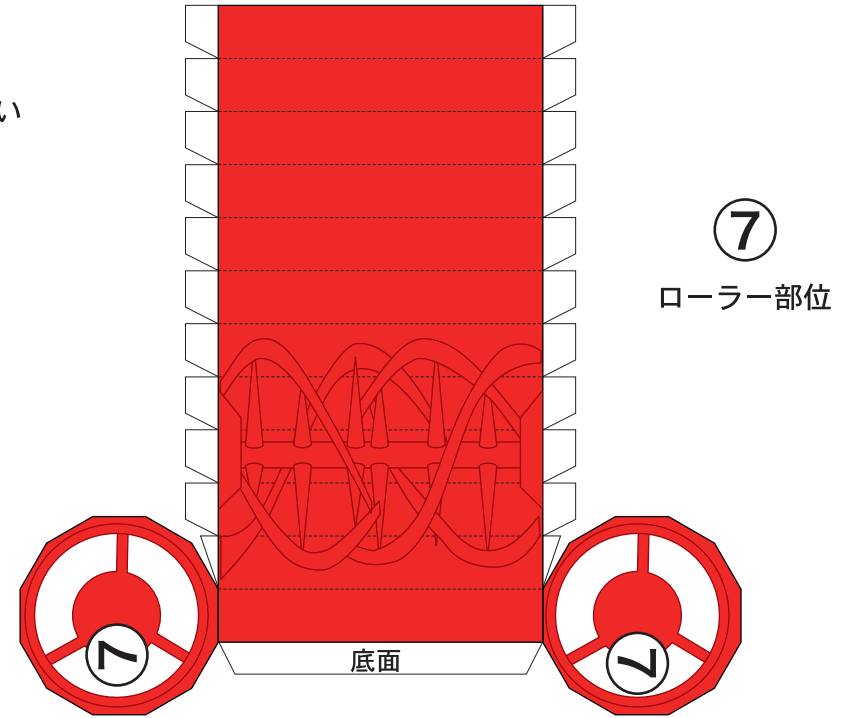
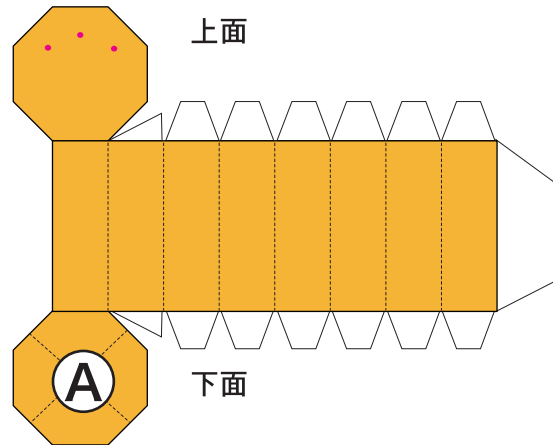
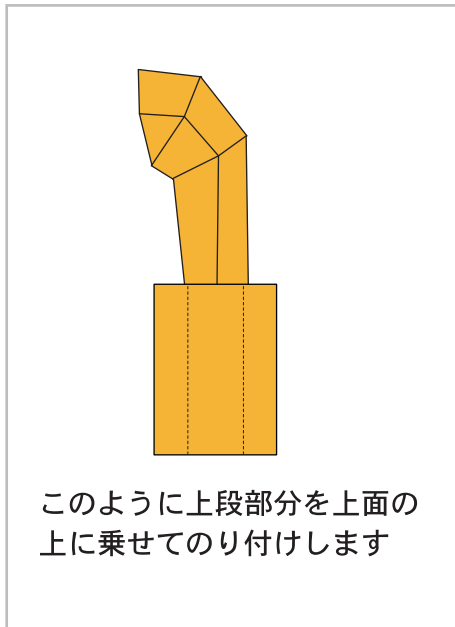

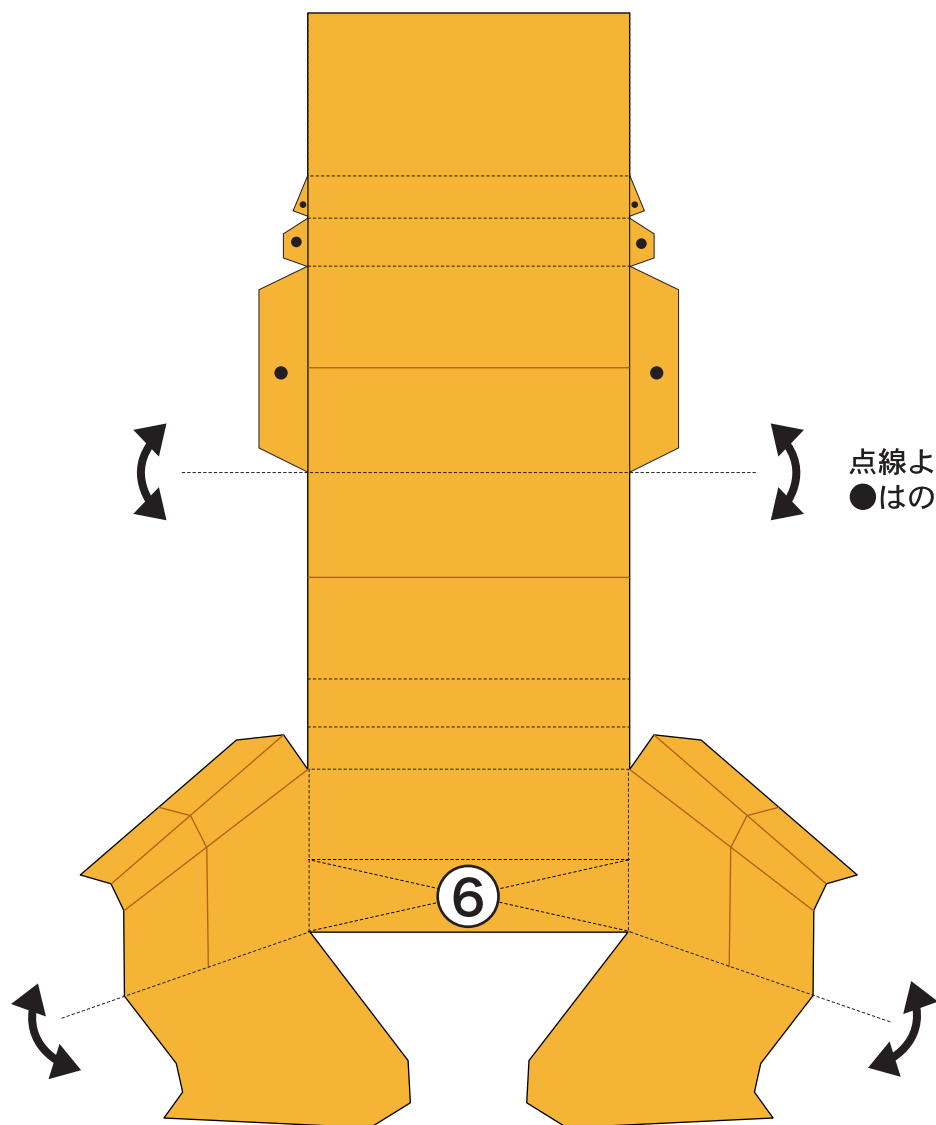

点線より裏返してのり付けしてください
●はのりしろになります。